





Installation Instructions for Magnasafe - MS8 & MS8-D

 <p style="text-align: center;">    </p>	<h4>Description</h4> <p>MAGNASAFE MS8 safety switches are extended range non-contact, magnetically operated switch and actuator. Designed to work with safety relays that have a low inrush current on the switch input, these switches provide an economical method of switching for the higher category, dual channel circuits.</p> <p>These safety switches are available in a robust ABS, or 316 Grade Stainless Steel housing, and both switch and actuator are fully sealed to IP67 & IP69K making them suitable for use in wet or dusty environments. They are easy to install and tolerant to misalignment. With correct installation, these safety switches comply with the guidelines given in EN14119.</p> <p>Magnasafe safety switches are designed to be used in part of safety related control system. A risk assessment should take place to establish that the specifications of these safety switches are suitable for the application required. See Technical Specifications below or contact Mechan Controls for further information.</p>
---	--

KEEP THIS GUIDE FOR FUTURE REFERENCE

The information is designed to help suitably qualified personnel install and operate Mechan Controls safety equipment. Before using this product, read this guide thoroughly along with any relevant European and/or National Standards E.g. Machinery Directive 2006/42/EC and its Amendments, Provision and Use of Work Equipment Regulations. Further information can be obtained from Mechan Controls Ltd.

Technical Specifications	MS8	MS8-SS	MS8-D
Contacts	2 NO or 2 NO + 1 NC	2 NO or 2 NO + 1 NC	2 NO + 1 NC
Safety Contact Rating	24Vdc / 400mA	24Vdc / 400mA	24Vdc / 400mA
Safety Contact Switching	30mm ON / 50mm OFF (Face to Face)	30mm ON / 50mm OFF (Face to Face)	30mm ON / 50mm OFF
	25mm ON / 40mm OFF (Side to Side)	25mm ON / 40mm OFF (Side to Side)	25mm ON / 40mm OFF
Auxiliary Contact Rating	24Vdc / 300mA	24Vdc / 300mA	24Vdc / 300mA
Auxiliary Contact Switching	30mm OFF / 40mm ON	30mm OFF / 40mm ON	30mm OFF / 40mm ON
Internal Fuse	-	-	-
External Fuse (<i>Customer Supplied</i>)	0.3 Amps Fast Acting	0.3 Amps Fast Acting	0.3 Amps Fast Acting
Construction	RED ABS	316 Grade Stainless Steel	316 Grade Stainless Steel
IP Rating	IP67 / IP69K	IP67 / IP69K	IP67 / IP69K
Operating Temperature	-25°C to +55°C	-25°C to +55°C	-25°C to +55°C
Fixing	M4 Torx security screws (Tightening Torque 1.0NM)	M4 Torx security screws (Tightening Torque 1.0NM)	M4 Torx security screws (Tightening Torque 1.0NM)
Connection	Pre-wired	Pre-wired or M12 Quick Disconnect	Pre-wired
Vibration	10 - 50Hz IEC 68-2-6	10 - 50Hz IEC 68-2-6	10 - 50Hz IEC 68-2-6
Shock	10g, 11ms IEC 68-2-27	10g, 11ms IEC 68-2-27	10g, 11ms IEC 68-2-27

Safety Related Data			
B10d	2,000,000	PFH	6.52 x 10 ⁻⁸
TM (Mission Time)	> 20 Years	PFHd	4.3 x 10 ⁻⁶ See Note 1
DC	99%	SFF	98%
MTTFd	High > 100 Years (Based on usage rate of 360 Days/Year, 24 Hours/Day, 10 Operations/Hour)		
Note 1: Based on dual channel wiring according to CAT 4. Diagnostic coverage provided by downstream control logic. DC - medium, MTTFd = 100 Years. Suitable for performance level applications PLe according to ISO 13849-1. (SIL 3 according to IEC 62061)			

Safety Standards	
Approvals	CE Complies with all relevant sections of the CE Marking Directive
	cUL 508 Industrial Control TUV Approved
International Directives	Machinery Directive 2006/42/EC, Low Voltage Directive 2006/95/EC; EMC Directive 2014/30/EU, RoHS Directive 2011/65/EC
International Standards	EN 12100 Safety of Machinery. General principles for design.
	EN ISO 14119 Safety of Machinery. Interlocking devices associated with guards. Principles for design and selection. EN ISO 13849 Safety of Machinery. Safety related parts of control systems.
	EN ISO 62061 Safety of Machinery. Functional safety of safety related electrical, electronic and programmable electronic control systems
	EN 60204 Safety of Machinery. Electrical equipment of machines.
	EN 60947-5-1 Low-voltage switchgear and controlgear. EN 60947-5-3 Low-voltage switchgear and controlgear.

Dimensions

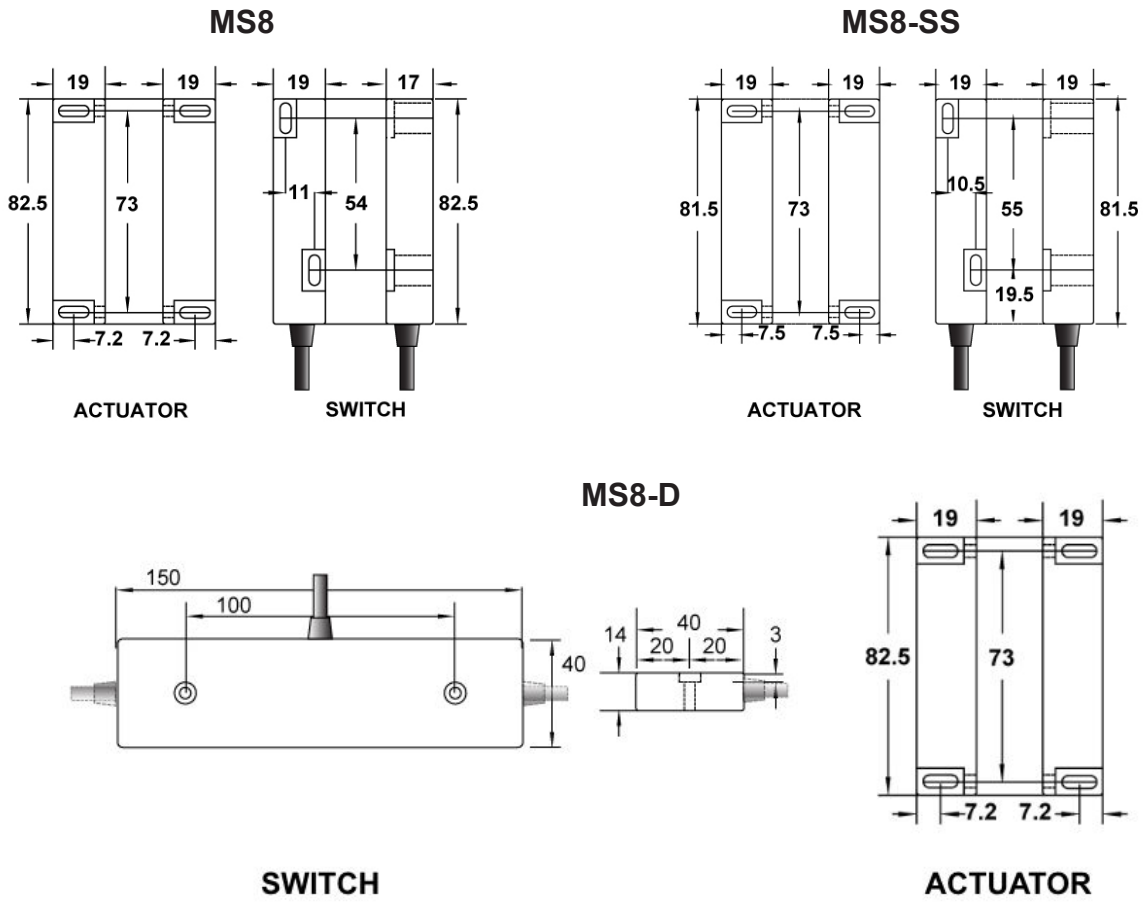

Mounting

The MS8 Safety Switch & Actuator has been designed with increased switching distance to suit certain applications. When mounting the switch & actuator on the machine guard cannot be opened sufficiently to allow access to the hazardous parts of the machinery before the machine has stopped.

Do not use safety switches as a stop. 1 mm separation when closed provides the best results.

Mount the switch on to the machine frame and the actuator on to the opening edge of the door.

Always try to mount the switch on non-ferrous material. (Ferrous materials may reduce the switching distance.)

EN14119: Hide the actuator where possible.

NOTES:

Minimum separation 50mm between adjacent switches

DO NOT mount on hinged side of the guard.

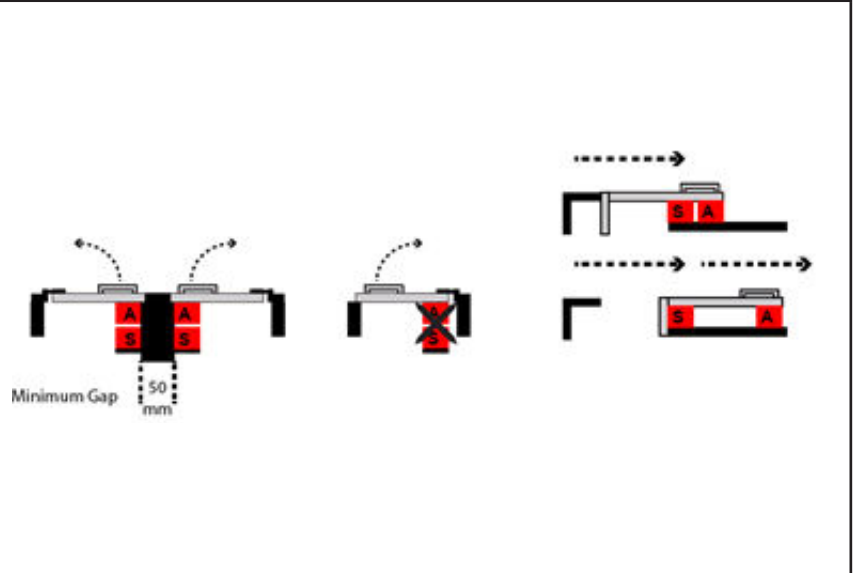

Connections & Fuses

PRE-WIRED

MS8-21, MS8-SS-21 & MS8-SS-D

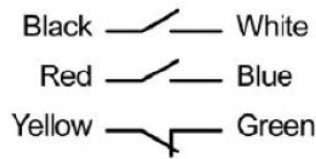

MS8-20

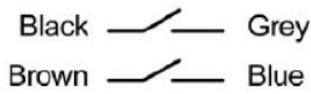

QUICK DISCONNECT

MS8-21-DC-QD & MS8-SS-21-DC-QD

Connector Contact Cable

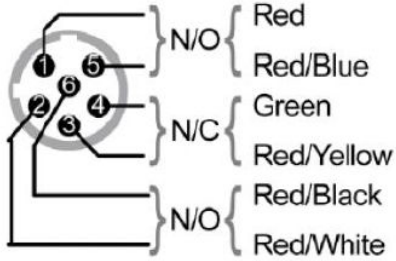

Connector
Micro 1/2" UNF
6 pole, Dual Key Way



MS8-SS-20-DC-QD-SP

Connector Contact

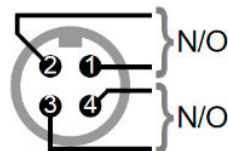

Connector
Micro DC M12

Operation

Magnasafe safety switches can approach each other from most directions. When closed the target printed on the front face of the switches must be aligned.

Please see switching faces below:

MS8-D

SIDE VIEW

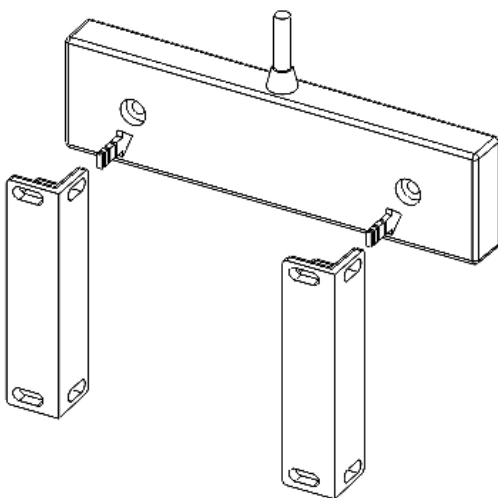

TOP VIEW

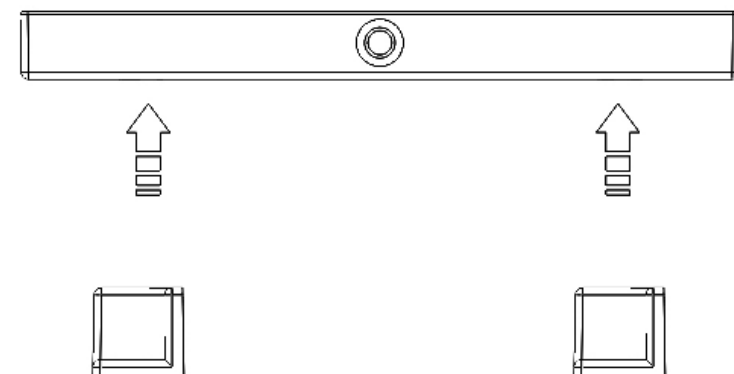

MS8

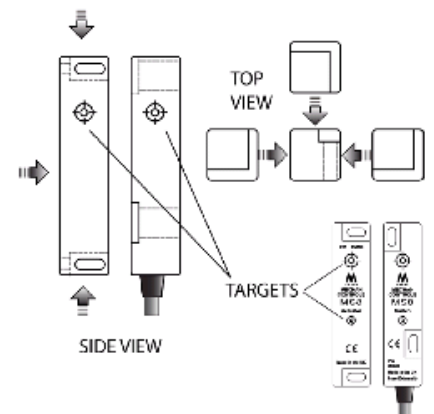

Installation Instructions for Magnasafe - MS8 & MS8-D

Recommend Safety Control Unit

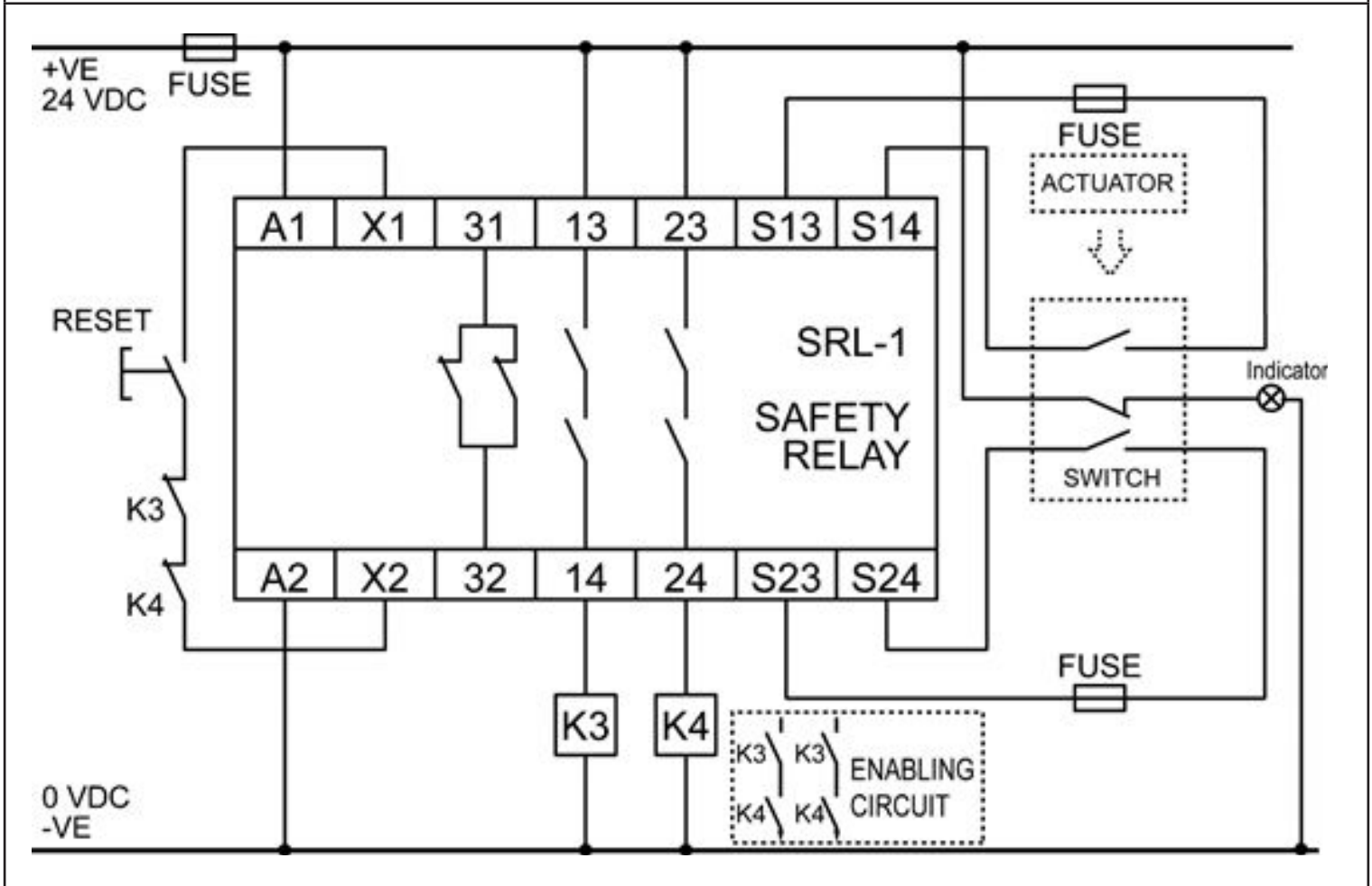

IMPORTANT

All control contacts should be externally fused.

Recommended Safety Control Unit Mechan Part Number: SRL-1 24VAC/DC or EM1 & ESM

Maintenance

It is recommended to check the safe operation of the switches and look for signs of damage or excessive wear on a weekly basis. Damaged units should be replaced or returned to the manufacturer for repair where practical.

Notes

In the interest of product development specifications are subject to change without notice. It is the responsibility of the user to ensure compliance with any acts or by-laws in place. All information regarding Mechan equipment is believed to be accurate at the time of printing. Responsibility cannot be accepted for errors or omissions.

350-403 Issue 6 - JAN 2019