



# 30.5 mm Pushbuttons T series & E34

**EATON**

*Powering Business Worldwide*

# Control and indication

## Eaton 30.5 mm pushbuttons



Eaton's 30.5mm pushbuttons are versatile, durable, rugged, & stand the test of time in even the most hostile environments.

The range includes momentary, illuminated & mushroom head pushbuttons, selector switches, indicating lights & push-pull units.

The T Series Chrome 30.5 mm pushbutton line features a zinc die cast construction with chrome-plated housing & mounting nut. The same durable construction is also available with the corrosive resistant E34 line of pushbuttons.

All operators are IP66 rated to protect against dirt & moisture. Additionally, most devices come complete with grounding hardware to prevent electrical shock. Rugged metal construction, handsome appearance, extra features, & competitive prices makes Eaton's 30.5mm range of pushbuttons the logical choice for OEM's & board builders looking for value, durability, & reliability.

### Features

- Die-cast metal housings create robust & heavy-duty devices that can endure repetitive & heavy handed use in industrial environments.
- IP66 rated for protection against dirt & moisture.
- The corrosion resistant E34 range can withstand extremely harsh environments.
- Contact blocks are colour coded (green for N.O. & red for N.C.) to permit easy identification & troubleshooting.
- Up to 6 contact blocks can stack on each other, allowing for up to 12 circuits per operator.
- Heavy-duty zinc die cast construction
- Enclosed silver contacts with reliability nibs
- All normally closed contacts have positive opening operation, i.e., normally closed contacts are forced open in the event of contact weld or spring breakage.
- Diaphragm seals with drainage holes
- Grounding nibs on the operator casing.
- Logic level contact blocks have palladium tipped contacts to ensure circuit integrity down to 1mA @ 5V AC/DC.
- Bright, long-lasting & vibration-proof LED's are available for illuminated operators.

### Standards

- CE EN60947-5-1
- UL 508 — File No. 131568
- CSA C22.2 No. 14 — File No. LR68551

### Contact blocks

Eaton's contact blocks feature enclosed silver contacts with pointed "reliability nibs" for reliable performance from logic level up to 600V. To ensure reliable switching, nibs bite through oxide which can form on silver contacts, eliminating the need for expensive logic level blocks for most applications. Reliability nibs improve performance in dry circuit, corrosive, fine dust & other contaminated atmospheres. Under normal environmental conditions, the minimum operational voltage is 5V & the minimum operational current is 1 mA, AC/DC. For operation under a wider range of environmental conditions, logic level contact blocks with inert palladium tipped contacts are recommended. Diaphragm Seal with Drainage Holes Eaton's pushbutton operators offer front-of-panel drainage via holes in the operator bushing. Hidden from view by the mounting nut, these holes prevent buildup of liquid inside the operator, which can prevent operation in freezing environments. The holes also provide a route for escaping liquid in high pressure washdowns, effectively relieving pressure from the internal diaphragm seal, ensuring reliable sealing every time.

### Grounding nibs

Most operators have green earthing screws to prevent electrical shock. Operators also have "grounding nibs" — four metal points on the operator casting designed to bite through most paints & other coatings on metal panels to enhance the ground connection when the operator is securely tightened.

### Standard Pushbuttons

#### Chrome, T Series pushbuttons

##### Chrome

The 30.5 mm pushbutton line features a zinc die cast construction with chrome-plated housing & mounting nut.

##### Applications for the chrome operators:

- Aggregate
- Automotive
- Construction Vehicles
- Industrial Equipment
- Material Handling
- Metal Forming
- Metal Stamping
- Mining
- Petrochemical
- Pulp & Paper

### Corrosion Resistant, E34 Pushbuttons

##### Corrosion resistant

Eaton's Corrosion Resistant E34 Range of 30.5 mm pushbuttons features the same rugged die cast construction of our T Series with an additional two-layer 100% solid thermosetting cathodic epoxy coating. This coating provides a smooth flat black smooth, flat back, corrosion resistant surface that has passed a demanding 600 hour salt spray test.

##### Applications for corrosion resistant operators:

- Automotive
- Chemical Plants
- Food & Beverage
- Food Service Equipment
- Industrial Equipment
- Mining
- Pulp & Paper
- Waste Water Treatment Plants

##### Ultraviolet light

E34 cathodic coating is not recommended for use in applications where exposure to ultraviolet light exists, use chrome operators.



### Standard Pushbuttons, flush, extended & half-shrouded buttons,



#### Flush button

Colour	Chrome	Corrosion resistant
● Black	<b>T101</b>	<b>E34PB1</b>
● Red	<b>T102</b>	<b>E34PB2</b>
● Green	<b>T103</b>	<b>E34PB3</b>
● Yellow	<b>T104</b>	<b>E34PB4</b>
● Grey	<b>T105</b>	-
○ White	<b>T106</b>	<b>E34PB5</b>
● Brown	<b>T107</b>	-
● Blue	<b>T108</b>	<b>E34PB6</b>

#### Extended button

Colour	Chrome	Corrosion resistant
● Black	<b>T111</b>	<b>E34EB1</b>
● Red	<b>T112</b>	<b>E34EB2</b>
● Green	<b>T113</b>	<b>E34EB3</b>
● Yellow	<b>T120</b>	<b>E34EB4</b>
○ White	<b>T116</b>	-
● Blue	<b>T118</b>	<b>E34EB6</b>

#### Half-shrouded

Colour	Chrome	Corrosion resistant
● Black	<b>T501</b>	<b>E34EVB1</b>
● Red	<b>T502</b>	<b>E34EVB2</b>
● Green	<b>T503</b>	<b>E34EVB3</b>
● Yellow	<b>T504</b>	<b>E34EVB4</b>
● Blue	<b>T508</b>	<b>E34EVB6</b>

#### Base mounted contact blocks

Description	Item no.
1NO 1NC	<b>T6</b>
2NO	<b>T7</b>
2NC	<b>T8</b>
1NC	<b>T52</b>
1NO	<b>T54</b>
1LONC 1ECNO	<b>T56</b>
1LONC 1ECNO	<b>T58</b>

#### Logic level contact blocks

Description	Item no.
1NO 1NC	<b>T1E</b>
2NO	<b>T2E</b>
2NC	<b>T3E</b>
1NC	<b>T51E</b>
1NO	<b>T53E</b>

#### Standard contact blocks

Description	Item no.
1NO 1NC	<b>T1P</b>
2NO	<b>T2P</b>
2NC	<b>T3P</b>
1NC	<b>T51P</b>
1NO	<b>T53P</b>
2NO 2NC	<b>T44</b>
1LONC 1ECNO	<b>T55</b>
1ECNO 1NO	<b>T57</b>
1LONC	<b>T71</b>
2LONC	<b>T45</b>



T1P



T44



T57

NO = Normally Open, NC = Normally Closed, LONC = Late Open Normally Closed, ECNO = Early Close Normally Open, Logic Level contact blocks have palladium contacts.

#### STEP 1



Select Pushbutton operator above.

#### STEP 2



Select contact block above.

# Control and indication

## Eaton 30.5 mm pushbuttons

### Mushroom operators momentary



#### Mushroom button 38.1mm

Colour	Chrome	Corrosion resistant
● Black	<b>T121</b>	<b>E34LB1</b>
● Red	<b>T122</b>	<b>E34LB2</b>
● Green	<b>T123</b>	<b>E34LB3</b>
● Yellow	<b>T124</b>	<b>E34LB4</b>
● Blue	<b>T129</b>	<b>E34LB6</b>

#### Palm head button 63.5mm zinc

Colour	Chrome	Corrosion resistant
● Black	<b>T171</b>	<b>E34JB1</b>
● Red	<b>T172</b>	<b>E34JB2</b>
● Red (Emergency Stop)	<b>T17213</b>	<b>E34JB2N</b>
● Green	<b>T173</b>	<b>E34JB3</b>

#### Accessories for complete push-pull operators\*

Description	Item no.
Padlock Assembly Kit	<b>6-A474</b>
Replacement Locking Tongue	<b>6-A475</b>
Padlock with Chain	<b>52-A1617</b>

#### Legend Plates

Engraving	Material	Item no.
STOP Pull to reset	Metal	<b>D2179-53CP</b>
STOP Pull to reset	Plastic	<b>E34LP179</b>

\* For use with push-pull mushroom operators maintained.

#### STEP 1



Select Pushbutton operator above.

#### STEP 2



Select contact block. (previous page)

### Mushroom operators components



#### Bare shaft operator for mushroom or palm pushbutton

Description	Item no.
Momentary, Spring Return	<b>T100</b>
Auto-Latch - Twist Base to Release	<b>T140</b>

#### 38.1 Mushroom button for bare shaft operators

Colour	Item no.
● Black	<b>T281</b>
● Red	<b>T282</b>
● Green	<b>T283</b>
● Yellow	<b>T284</b>
● Blue	<b>T288</b>

#### 63.5Mm palm button (anodized aluminium) for bare shaft operators

Colour	Item no.
● Black	<b>T291</b>
● Red	<b>T292</b>
● Green	<b>T293</b>

#### STEP 1



Select bare shaft operator above.

#### STEP 2



Select mushroom button above

#### STEP 3



Select contact block. (previous page)



### Push-pull mushroom operators maintained



T129P



T176P



T129M



E34129S

### Push-pull operators complete padlockable

Head diameter	Colour	Material	Chrome	Corrosion resistant
45mm	Red	Zinc	<b>T129P</b>	<b>E34129P</b>
63.5mm	Red	Zinc	<b>T176P</b>	<b>E34176P</b>

### Push-pull operators complete non-padlockable

Head diameter	Colour	Material	Chrome	Corrosion resistant
38mm	Red	Plastic	<b>T129S</b>	<b>E34129S</b>
45mm	Red	Zinc	<b>T129M</b>	<b>E34129M</b>
63.5mm	Red	Zinc	<b>T176M</b>	<b>E34176M</b>

#### STEP 1



Select Pushbutton operator above.

#### STEP 2



Select contact block.  
(previous page)

### Push-Pull operators components



#### Push-pull operators

Description	Position	Chrome	Corrosion resistant
Maintained Push & Pull	2	<b>T5</b>	<b>E34GDB</b>
Momentary Push & Pull	3	<b>T4</b>	<b>E34GEB</b>
Maintained Push & Momentary Pull	3	<b>T9</b>	<b>E34GFB</b>

#### 38.1mm mushroom button for push-pull operators

Description	Colour	Item no.
Operator Head	● Black	<b>E34C1</b>
Operator Head	● Red	<b>E34C2</b>
Operator Head	● Red (Emergency Stop)	<b>10250TB63</b>
Operator Head	● Green	<b>E34C3</b>

#### 63.5mm palm button (anodized aluminium) for push-pull operators

description	Colour	Item no.
Operator Head	● Red	<b>E34J2</b>
Operator Head	● Red (Emergency Stop)	<b>E34J2N8</b>

#### STEP 1



Select push-pull operator above.

#### STEP 2



Select mushroom button above

#### STEP 3



Select contact block.  
(previous page)

# Control and indication

## Eaton 30.5 mm pushbuttons

### Illuminated operators, indicating light lenses

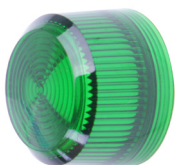

#### Plastic lenses

Colour	Plastic
● Red	<b>E34H2</b>
● Green	<b>E34H3</b>
● Amber	<b>E34H9</b>
○ Clear	<b>E34H0</b>
● Yellow	<b>E34H4</b>
○ White	<b>E34H5</b>
● Blue	<b>E34H6</b>

#### Glass lenses (chrome)

colour	Glass (chrome)
● Red	<b>TC7N</b>
● Green	<b>TC8N</b>
● Amber	<b>TC9N</b>
○ Clear	<b>TC11N</b>
○ White	<b>TC12N</b>
● Blue	<b>TC10N</b>

#### Glass lenses (corrosion resistant)

Colour	Glass (corrosion resistant)
● Red	<b>E34G2</b>
● Green	<b>E34G3</b>
● Amber	<b>E34G9</b>
○ Clear	<b>E34G0</b>
● Yellow	<b>E34G4</b>
○ White	<b>E34G5</b>
● Blue	<b>E34G6</b>

### Indicating Light Units



#### Direct voltage indicating light unit

Description	Voltage	Chrome	Corrosion resistant
Direct voltage - order bulb separately	6-240V	<b>T197N</b>	<b>E34FB197L*</b>

See next page for bulbs.  
Can be used with LEDs.

\*LED only 6-240V

#### Resistor type indicating light units

Description	Voltage	Chrome	Corrosion resistant
Resistor Type 120V bulb supplied	110/120	<b>T201N</b>	<b>E34RB120</b>
	220/240	<b>T202N</b>	<b>E34RB240</b>

#### Incandescent bulb indicating light units

Description	Voltage	Chrome	Corrosion resistant
With incandescent bulb supplied	6	<b>T197N/2</b>	<b>E34FB06</b>
	12	<b>T197N/3</b>	<b>E34FB12</b>
	24	<b>T197N/4</b>	<b>E34FB24</b>
	48	<b>T197N/5</b>	<b>E34FB48</b>
	110	<b>T197N/7</b>	<b>E34FB110</b>
	240	<b>T197N/8</b>	<b>E34FB240</b>

#### Transformer type indicating light units

Description	Voltage	Chrome	Corrosion resistant
Transformer Type 6V Secondary bulb supplied	110/120	<b>T181N</b>	<b>E34TB120</b>
	220/240	<b>T182N</b>	<b>E34TB240</b>
	380/415	<b>T183N</b>	<b>E34TB380</b>
	440/480	<b>T184N</b>	<b>E34TB480</b>
	550/600	<b>T185N</b>	<b>E34TB600</b>
	415	-	<b>E34TB415</b>

#### STEP 1

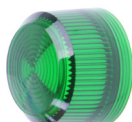

Select a lens from above.

#### STEP 2



Select indicating light above

#### STEP 3



Select bulb (if not supplied)  
(next page)

#### STEP 4



Select contact block.  
(previous page)

### Illuminated operators, illuminated pushbutton lenses



#### Plastic illuminated lenses

Colour	Plastic
● Red	<b>E34V2</b>
● Green	<b>E34V3</b>
● Amber	<b>E34V9</b>
○ Clear	<b>E34V0</b>
● Yellow	<b>E34V4</b>
○ White	<b>E34V5</b>
● Blue	<b>E34V6</b>

#### Glass illuminated lenses (chrome)

Colour	Glass (chrome)
● Red	<b>TC13N</b>
● Green	<b>TC14N</b>
● Amber	<b>TC15N</b>
○ Clear	<b>TC17N</b>
○ White	<b>TC18N</b>
● Blue	<b>TC16N</b>

#### Glass illuminated lenses (chrome) (corrosion resistant)

Colour	Glass (chrome)
● Red	<b>E34P2</b>
● Green	<b>E34P3</b>
● Amber	<b>E34P9</b>
○ Clear	<b>E34P0</b>
● Yellow	<b>E34P4</b>
○ White	<b>E34P5</b>
● Blue	<b>E34P6</b>

### Press-to-test light units



### Illuminated pushbutton light units



#### Press-To-Test Indicating Lights - Direct Voltage

Description	Supply voltage	Chrome	Corrosion resistant
Direct voltage order bulb separately	6-240V	<b>T230N</b>	<b>E34FPB</b>
	380/415	<b>T413</b>	<b>E34XB380</b>

See next page for bulbs.  
Can be used with LEDs.

#### Illuminated pushbuttons - transformer type

Description	Supply voltage	Chrome	Corrosion resistant
Transformer type 6V secondary bulb supplied	110/120	<b>T411</b>	<b>E34XB120</b>
	220/240	<b>T412</b>	<b>E34XB1240</b>
	380/415	<b>T413</b>	<b>E34XB380</b>
	440/480	<b>T414</b>	<b>E34XB480</b>

#### Direct Voltage Indicating Light Unit

Description	Supply voltage	Chrome	Corrosion resistant
Direct voltage - order bulb separately	6 - 240V	<b>T441</b>	<b>E34CB 497L*</b>

See next page for bulbs.  
Can be used with LEDs.

\*LED only 6-240V

#### Press-to-test indicating lights - transformer type

Description	Supply voltage	Chrome	Corrosion resistant
Transformer Type 6V, 1W secondary bulb supplied	110/120	<b>T221N</b>	<b>E34TPB120</b>
	220/240	<b>T222N</b>	<b>E34TPB240</b>
	380/415	<b>T223N</b>	<b>E34TPB380</b>

#### Press-to-test indicating lights - resistor type

Description	Supply voltage	Chrome	Corrosion resistant
Resistor Type 120V, bulb supplied	110/120	<b>T231N</b>	<b>E34RPB120</b>
	220/240	<b>T240N</b>	<b>E34RPB240</b>

#### STEP 1



Select a lens from above.

#### STEP 2



Select light from above

#### STEP 3



Select bulb (if not supplied)  
(next page)

#### STEP 4



Select contact block.  
(previous page)

# Control and indication

## Eaton 30.5 mm pushbuttons

### Illuminated operators, push-pull mushroom lenses



#### Standard push-pull lenses

Colour	Item no.
● Red	<b>E34M2</b>
● Red (Emergency Stop)	<b>E34M2N8</b>
● Green	<b>E34M3</b>
● Amber	<b>E34M9</b>
○ Clear	<b>E34M0</b>
○ White	<b>E34M5</b>
● Blue	<b>E34M6</b>

#### Side lighted anodised aluminium lenses

Colour	Item no.
● Red	<b>10250TC57</b>
● Red (Emergency Stop)	<b>10250TC63</b>
● Green	<b>10250TC58</b>
● Amber	<b>10250TC64</b>
○ Clear	<b>10250TC62</b>
○ White	<b>10250TC61</b>
● Blue	<b>10250TC59</b>

### Illuminated push-pull operators



#### Illuminated push-pull operators

Description	Supply voltage	Chrome	Corrosion resistant
Maintained Push & Pull	2	<b>T5</b>	<b>E34GDB</b>
Momentary Push & Pull	3	<b>T4</b>	<b>E34GEB</b>
Maintained Push & Momentary Pull	3	<b>T9</b>	<b>E34GFB</b>

### Light units for illuminated push-pull operators



#### Direct voltage light modules for push-pull operators

Description	Voltage	Item no.
Direct Voltage	6-240V	<b>10250T70</b>

Order bulb separately - see next page for bulbs.  
Can be used with LEDs.



#### Transformer type light modules for push-pull operators

Description	Voltage	Item no.
	110/120	<b>10250T63</b>
Transformer Type 6V secondary bulb supplied	220/240	<b>10250T65</b>
	380/415	<b>10250T66</b>
	440/480	<b>10250T67</b>



#### Resistor type light modules for push-pull operators

Description	Voltage	Item no.
Resistor Type 120V bulb supplied	120	<b>10250T80</b>
	240	<b>10250T81</b>

#### STEP 1



Select a lens from above.

#### STEP 2



Select push-pull operator from above

#### STEP 3



Select light unit from above

#### STEP 4



Select bulb (if not supplied)

#### STEP 5



Select contact block. (previous page)



### Illuminated operators, bulbs



#### Incandescent bulbs

Supply voltage	Watts	Item no.
6.3V	0.9W	28-2225-33
24V	1.2W	28-2225-13
130V	2.2W	28-2225-24



#### Super bright LED bulbs

(recognisable in outdoor daylight applications - ac/dc)

Colour	6-12V	24V	120V
Red	E22LED612RN	E22LED024RN	E22LED120RN
Green	E22LED612GN	E22LED024GN	E22LED120GN
Yellow	E22LED612YN	E22LED024YN	E22LED120YN
White	E22LED612WN	E22LED024WN	E22LED120WN



#### Bright LED bulbs - single chip (ac/dc)

Colour	6V	12V	24V
Red	21BA9SL6R	21BA9SL12R	21BA9SL24R
Green	21BA9SL6V	21BA9SL12V	21BA9SL24V
Yellow	21BA9SL6G	21BA9SL12G	21BA9SL24G
White	21BA9SL6W	21BA9SL12W	21BA9SL24W

#### Bright LED bulbs - single chip (ac/dc)

Colour	110V	240V
Red	21BA9SL110R	21BA9SL240R
Green	21BA9SL110V	21BA9SL240V
Yellow	21BA9SL110Y	21BA9SL240A
White	21BA9SL110W	21BA9SL240W



#### Neon bulbs

Supply voltage	Colour	Item no.
110V	Clear	BA9S110N
240V	Clear	BA9S240N
240V	Green	BA9S240NG
240V	Red	BA9S240NR

# Control and indication

## Eaton 30.5 mm pushbuttons

### Selector switch operators,

#### 2 Position selector switches



Description (M = Maintained, S = Spring Return)	Chrome	Corrosion resistant
	<b>T4011</b>	<b>E34VFB</b>
	<b>T4081</b>	<b>E34VEB</b>

#### 4 Position selector switches

Description (M = Maintained, S = Spring Return)	Cam code*	Chrome	Corrosion resistant
Maintained	7	<b>T4067</b>	<b>E34VTB</b>

\* See cam selection chart to determine cam code.

#### 3 Position selector switches

Description (M = Maintained, S = Spring Return)	Cam code*	Chrome	Corrosion resistant
	2	<b>T4022</b>	<b>E34VGB</b>
	3	<b>T4023</b>	<b>E34VHB</b>
	4	<b>T4024</b>	-
	6	<b>T4026</b>	-
	2	<b>T4032</b>	<b>E34VJB</b>
	3	<b>T4033</b>	<b>E34VKB</b>
	2	<b>T4042</b>	<b>E34VLB</b>
	3	<b>T4043</b>	<b>E34VMB</b>
	2	<b>T4052</b>	<b>E34VNB</b>
	3	<b>T4053</b>	<b>E34VPB</b>



E34K1



T341M



E34L1



E34A1

### Selector switch knobs & levers

#### Knobs & levers

Description	Material	Item no.
Knob	Plastic	<b>E34K1</b>
	Metal	<b>T341M</b>
Lever	Plastic	<b>E34L1</b>
	Plastic	<b>E34A1*</b>

\* For maintained operators only.

### Selector switches & joystick operators, cam selection guide

#### Cam selection chart showing contact sequence

Item No. of contact block	Circuit ①	Position selector switch					
		2	3	3	3	3	4
		Cam code no. 1	Cam code no. 2	Cam code no. 3	Cam code no. 4	Cam code no.6	Cam code no.7
T1P	A.N.C.	XO	OXO	OXX	XOO	XOO	XOOO
	B.N.O.	OX	OOX	OOX	OXO	OXO	OXOO
T1P	A.N.O.	OX	XOX	XOO	OXX	OOX	OOXO
	B.N.C.	XO	XXO	XXO	XOX	OOX	OOOX
T2P	A.N.O.	OX	XOX	XOO	OXX	OOX	OOXO
	B.N.O.	OX	OOX	OOX	OXO	OXO	OXOO
T3P	A.N.C.	XO	OXO	OXX	XOO	XOO	XOOO
	B.N.C.	XO	XXO	XXO	XOX	OOX	OOOX

Switching angle 60° between each position. Rated for ac only. Refer to actual installation instructions given with each switch for additional switching combinations. To determine the number of the cam you require & the correct contact block, select the contact sequence desired from table above. O = contacts open, x = contacts closed. The cam number is shown at top of column. The item number of the appropriate contact block is shown in column 1. At extreme left of table.

① Each contact block contains two contact circuits. The top set of contacts is identified as 'circuit a' & the lower set as 'circuit b' is indicated in the table. The chart shows the contact arrangements with the three contact blocks available & in each operator position. Additional contacts are obtainable by stacking contact blocks up to a maximum of 6 blocks (12 circuits). A maximum of 2 can be used with cam 6.

#### STEP 1



Select bare shaft operator (previous page)

#### STEP 2

Choose cam based on contact sequence from cam selection guide table above (applies to 3 position selector switches only)

#### STEP 3



Select knob or lever



#### STEP 3



Select contact block. (previous page)

### Key operated selector switches

#### 2 Position key operated selector switches



2 Position	Cam	Key removal	Chrome	Corrosion resistant
	-	Right & Left	<b>T15113</b>	<b>E34KFB3</b>
	-	Left Only	<b>T15712</b>	<b>E34KEB2</b>

#### Spare key

Description	Item no.
Replacement Keys (2)	<b>TA152</b>

Other key codes are available contact eaton for more information.

#### 3 Position key operated selector switches

3 Position	Cam	Key removal	Chrome	Corrosion resistant
	2	Left Right & Centre	<b>T15227</b>	<b>E34KGB7</b>
	3	Left Right & Centre	<b>T15237</b>	<b>E34KHB7</b>
	4	Left Right & Centre	<b>T15247</b>	-
	6	Left Right & Centre	<b>T15267</b>	-
	2	Right & Centre	<b>T15325</b>	<b>E34KJB5</b>
	3	Right & Centre	<b>T15335</b>	<b>E34KKB5</b>
	2	Centre Only	<b>T15424</b>	<b>E34KLB4</b>
	3	Centre Only	<b>T15434</b>	<b>E34KMB4</b>



#### STEP 1



Select switch operator

#### STEP 2

Choose cam based on contact sequence from cam selection guide table above (applies to 3 position selector switches only)

#### STEP 3



Select contact block.  
(previous page)

# Control and indication

## Eaton 30.5 mm pushbuttons



### Selector switches & joystick operators, joystick operators

**Two-Position Joystick Operators**  
The device mounts in the standard 30.5 mm mounting hole.

**Four-Position Joystick Operators**  
The joystick operated control unit is intended for AC application only. The panel area required for the 4-position operator is equivalent to two standard pushbutton operators.

**Latched Joystick Operators**  
The latch holds the lever in the centre position. The trigger latch must be released before lever can moved into any position.

### 2 Position joystick operator

Description	Item no.
2 position operator - Momentary Up & Down	<b>T452</b>

### 4 Position joystick operators (spring return only)

Description	Item no.
4 position - Without Latch	<b>T450</b>
4 position - With Latch	<b>T460</b>

### 4 Position joystick operators (maintained)

Description	Item no.
4 position - Without Latch	<b>10250 T451_*</b>
4 position - With Latch	<b>10250 T461_*</b>

\*Maintained Position  
For maintained position (non-spring return), locate required maintained position or positions of operating lever in the Maintained table below & add appropriate Suffix Number to the Item Number selected from the table above.

### Maintained positions

Up	Down	Left	Right	Suffix No.*
X	—	—	—	1
—	X	—	—	2
—	—	X	—	3
—	—	—	X	4
X	X	—	—	5
X	—	X	—	6
X	—	—	X	7
—	X	X	—	8
—	X	—	X	9
—	—	X	X	10
X	X	X	—	11
X	X	—	X	12
X	—	X	X	13
—	X	X	X	14
X	X	X	X	15

### Contact block selection & mounting

Handle position			Contact block	Mounting location	Mounting location	
Up	Centre	Down			Top	Bottom
			Item no.	Type	A	B
X	O	O	T51P	1NC		
O	O	X	T51P	1NC		
O	X	O	T45	2LONC		
X	O	O	T3P	1NC		
O	O	X		1NC		
X	X	O	T45	1LONC		
O	X	X		1LONC		
X	O	O	T44	1NC		
O	O	X		1NO		
O	O	X		1NC		
V	O	O		1NO		

X = closed circuit, O = open circuit.  
NO = Normally Open, NC = Normally Closed, LONC = Late Opening Normally Closed.  
Four circuits in single block depth — rated 300V max.

### Two-position joystick operators - contact block operation

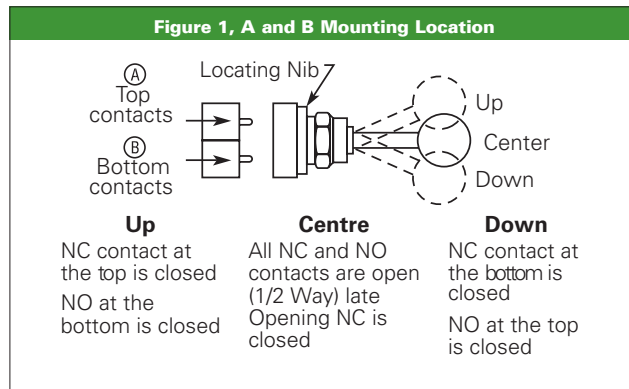

### Four-position joystick operators - contact block operation

Contact blocks mount directly on the back of the operator. For reliable operation, the maximum number of contact blocks that should be installed behind each operator lever is 2 (4 contacts total). Figure 2 identifies the circuits activated by each of the eight possible lever positions. Contact block plungers 1, 2, 3, 4 are depressed (change state) when handle is in the position indicated by arrows in Figure 2.

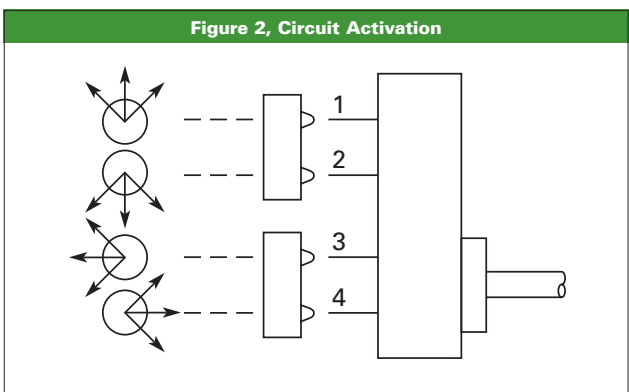

### Application caution

Joystick operators are not recommended on certain DC applications above 24V DC which may involve lightly engaging the contacts (teasing) to achieve speed control, positioning, jogging, etc. Excessive arcing & deterioration of the contacts will occur.



### Pushbuttons, Control station and Enclosures

Standard pushbuttons, flush, extended & half-shrouded buttons,

#### Diecast aluminium enclosures

##### Standard

No. Of holes	Single - depth T series	Corrosion resistant
1	TN1	E34N1
2	TN2	E34N2
3	TN3	E34N3
4	TN4	E34N4

#### Corrosion resistant

No. of holes	Double depth T series	Corrosion resistant
1	TN11	E34N11
2	TN12	E34N12
3	TN13	E34N13
4	TN14	E34N14
6	TN15	-

1-2 Hole: 3/4 inch conduit entry hole, 2-6 hole: 1 inch conduit bottom-entry hole, 1.5 Inch unf thread IP66.



TN4

TN2

TN11

#### Stainless steel enclosures

##### Stainless steel

No. of holes	316 Stainless
1	XBS130
2	XBS230
3	XBS330
4	XBS430
6	XBS630
8	XBS830
9	XBS930

#### Fibreglass enclosures

##### Fibreglass

No. of holes	Item no.
1	TFG11
2	TFG12
3	TFG13

20mm non-threaded conduit bottom-entry hole IP66, UV stabilised.



XBS330

TFG12

#### Assembled control stations

##### Push-pull stop stations (padlockable)

Operator head	Contacts	Item no.
Metal mushroom 45mm	1LONC	10250T700M
	1ECNO,1LONC	10250T701M
Metal palm 63.5mm	1LONC	10250T700P
	1ECNO,1LONC	10250T701P



10250T700P

##### "Staylock" push-pull stop stations (non-padlockable)

Operator head	Contacts	Padlock included	Item no.
Metal Mushroom 45mm	1LONC	NO	ESM9/5
	1LONC	YES	ESM9/5P
	1ECNO,1LONC	NO	ESM9/6
	1ECNO,1LONC	YES	ESM9/6P
Metal Palm 63.5mm	1LONC	NO	ESP6/5
	1LONC	YES	ESP6/5P
	1ECNO,1LONC	NO	ESP6/6
	1ECNO,1LONC	YES	ESP6/6P



ESM9/6

##### Stop start pushbutton station

Description	Item no.
Fibreglass Enclosure. Start: green pushbutton with boot Stop: red padlockable mushroom with boot	T3500



T3500

# Control and indication

## Eaton 30.5 mm pushbuttons



TA38



TA2



TA26



10250TA64



TA48



TA85



TA25



10250TA6  
E34TA6



10250TA12  
E34TA12



10250TA15  
E34TA15



TA56  
10250TA56Y



10250ED1241



TA8



TA22

### Accessories

Padlock attachments	Description	Item no.
With hinged transparent flap. For flush or extended pushbuttons, & knob-operated selector switches	Plastic Cover	<b>TA38</b>
For flush stop button. Permits locking NC contacts in open position with padlock. Prevents operation of button. Will not lock NO contact	Chrome	<b>TA2</b>
	Corrosion resistant	<b>E34TA2</b>
For extended pushbutton. Permits locking NC contacts in open position with padlock	Chrome	<b>TA26</b>
For illuminated pushbuttons. Locks in down position only	Chrome	<b>10250TA64</b>

Boots	Colour	Item no.	
Protective boot for flush pushbutton operators	Clear	<b>10250TA46</b>	
	Blue	<b>91000TA46</b>	
	Black	<b>TA47</b>	
	Red	<b>TA48</b>	
	Green	<b>TA49</b>	
	Yellow	<b>TA50</b>	
	Protective boot for extended pushbutton operators	Black	<b>TA3</b>
		Red	<b>TA4</b>
Green		<b>TA10</b>	
Protective boot for illuminated pushbuttons.	Clear	<b>TA85</b>	
	Black	<b>TA88</b>	
Protective boot for momentary mushroom operators on page 295. Not suitable for use with T140 operator.			

Shrouds & guards	Description	Item no.
Shroud for Mushroom Head Operator	Prevents accidental operation. Not for push-pull operators. Momentary operators only	<b>10250TA6 E34TA6</b>
Extended Retaining Nut	Replaces standard nut & provides guard for flush head pushbutton operators.	<b>10250TA12 E34TA12</b>
Guard for Illuminated Pushbutton	Guard for Illuminated Pushbutton	<b>10250TA15 E34TA15</b>
Shroud	For jumbo mushroom head operator. Available in Grey & Yellow (Not for push-pull operators, momentary operators only.)	<b>TA56 10250TA56Y</b>
Half Shroud – Yellow	For jumbo mushroom head operator.	<b>10250ED1241</b>

Hardware & kits	Description	Item no.
Fingerproof Shroud	10 per Package Fits new style contact blocks & light units.	<b>10250TA101</b>
Spacer Ring	Used when legend plate is not required.	<b>TA8</b>
Base Mounting Spacers	Equivalent to contact block in depth — Complete with screws, washers, etc. For use in pushbutton stations for base mounting contact blocks. 1 Block Deep 2 Blocks Deep	<b>TA22 TA23</b>

### Accessories

Special operators & attachments	Description	Item no.
Wobble Stick	Complete with retaining nut — fits standard button.	<b>TA5</b>
Maintained Contact Attachment	Mechanically interlocks two buttons & provides position indication for one. Use with two pushbutton operators & one or more contact blocks.	<b>TA1</b>

Hole plugs	Description	Item no.
Plug	For unused holes — Steel, painted grey	<b>10250TA7</b>
Stainless Steel Plug	For unused holes — Stainless Steel - Square	<b>E30KT5</b>

Tools	Description	Item no.
Octagonal Tool	Octagonal notched to fit over selector switch lever	<b>10250TA95</b>
Tool for Tightening Boots	Used to install boot	<b>TA96</b>
Allen Key	Used for removal of jumbo mushroom head.	<b>10250TA102</b>

Special light modules	Description	Item no.
Flasher Module	Changes any AC illuminated device to a controlled flashing light. 24V s 120V	<b>TFL2</b> <b>TFL1</b>



TA5



TA1



10250TA7



10250TA95



TA96



10250TA102



TFL2

### Legend Plates

Description	Item no.
Aluminium T-Range, large size, black unless marked "red"	<b>TJ_ _</b>
Aluminium T-Range, medium size, black unless marked "red"	<b>TM_ _</b>
Stainless steel T-Range, medium size, black, blank	<b>TM36S</b>
Stainless steel T-Range, medium size, red, blank	<b>TM37S</b>
Plastic E34 range universal size, black unless marked "red"	<b>E34SP_ _</b>

Legend	T-Range large Item no.	T-Range medium Item no.	E34 universal Item no.
Blank	<b>TJ36</b>	<b>TM36</b>	<b>TSP76</b>
Blank (red)	<b>TJ37</b>	<b>TM37</b>	<b>TSP77</b>
Off (red)	<b>TJ24</b>	<b>TM24</b>	<b>E34SP24</b>
On	<b>TJ25</b>	<b>TM25</b>	<b>E34SP25</b>
Run	<b>TJ31</b>	<b>TM31</b>	<b>E34SP31</b>
Start	<b>TJ33</b>	<b>TM33</b>	<b>E34SP33</b>
Stop (red)	<b>TJ34</b>	<b>TM34</b>	<b>E34SP34</b>

# Control and indication

## Eaton 30.5 mm pushbuttons

### 30.5mm Pushbuttons, dimensions & technical data

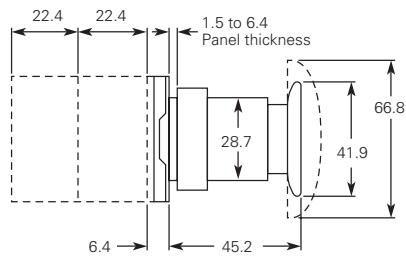

**Push-Pull Switch**

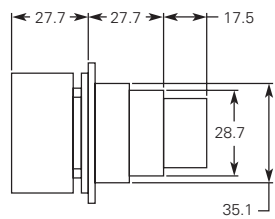

**Illuminated Pushbutton**

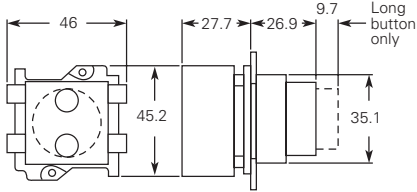

**Flush and long pushbutton half shroud is the same as the long pushbutton with lower half of guard ring cut back**

Operator	Dim. A
Knob	35.1
Lever	38.1

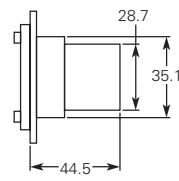
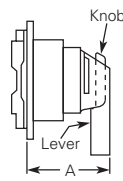

**Key operated selector switch**

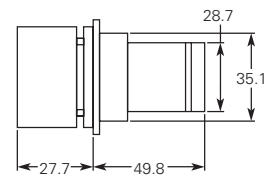

**Illuminated Selector Switch**

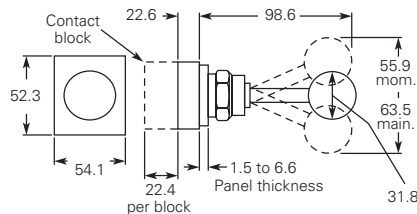

**2-position joystick operator**

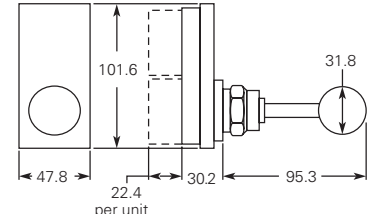

**4-position joystick operator**

Flexible boot for protecting flush or long push button  
Catalogue no. 10250TA3  
Typical

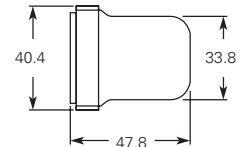
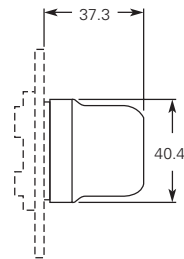

Transparent flexible boot for illuminated pushbutton  
Catalogue no. 10250TA25

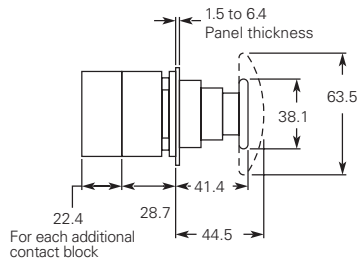

**Mushroom and jumbo head pushbutton**

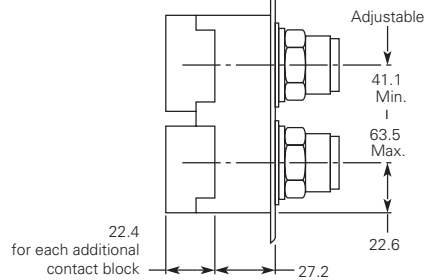

**Maintained Pushbutton Catalog No. 10250TA66 Typical**

Lens	Dimension A
Plastic	35.1
Glass	39.6

Approximate Dimensions in mm

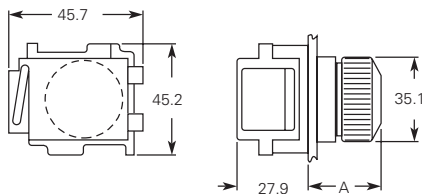

**Indicating Light - Transformer Type**

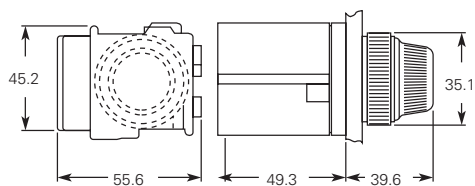

**Press-To-Test Indicating Light - Transformer Type**

### Diecast aluminium enclosure dimensions

	Wide	High	Single depth	Double depth
1	98.6	101.6	57.2	76.3
2	98.6	149.4	57.2	76.3
3	98.6	196.9	57.2	76.3
4	98.6	244.6	57.2	76.3

### Fibreglass enclosure dimensions

	Wide	High	Deep
1	97	100	75
2	97	150	75
3	97	200	75

### 316 Stainless steel enclosure dimensions

	Wide	High	Deep
1	120	120	84
2	120	160	84
3	120	220	84
4	120	280	84



### 30.5mm Pushbuttons, dimensions & technical data

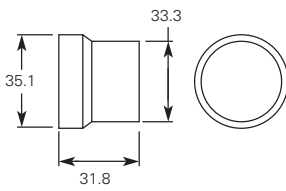

**Extended Retaining Nut**  
Catalog No. 10250TA12

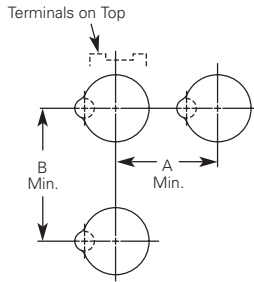

**Horizontal Rows**

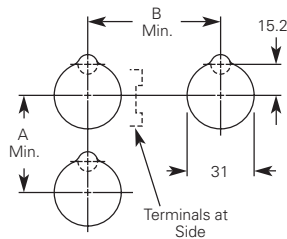

**Vertical Rows**

### Panel drilling and minimum spacing

Legend plate	Dim. in mm	
	A Min	B Min.
<b>1 or 2 Circuit contact blocks</b>		
Small or None	41.4	57.2
Standard	44.5	57.2
Jumbo ①	57.2	57.2
Extra Large	63.5	66
<b>4 Circuit contact block 10250T44</b>		
Small or None	47.8	57.2
Standard	47.8	57.2
Jumbo ①	57.2	57.2
Extra Large	63.5	66

① If Jumbo plates are to be placed one above the other vertically, add 3.3 to minimum dimensions listed.

Note: Locating nib hole or notch is 3.45 - 3.56 mm #29 drill.

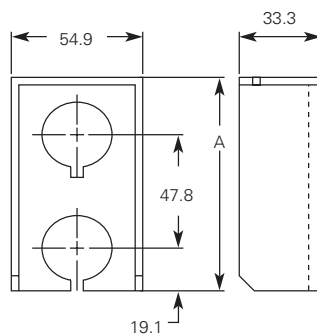

**Multiple Button Guard**

Number of elements	Dimension A
2	101.6
3	149.4
4	202.2
7	339.9

Legend plate	Dim. in mm	
	A	B
<b>1/2 Round Legend Plates</b>		
Small	39.6	23.1
Standard	40.4	27.2
Jumbo	52.3	38.9
<b>Square Legend Plates</b>		
Small	40.4 Sq.	22.9
Standard	44.5 Sq.	26.9 ②
Jumbo	55.6 Sq.	38.1
Extra Large	62.0 Sq.	41.4

② For plastic legend plate, Dimension B is 28.4

Enclosure size (No. of elements)	Dimensions in inches (mm)			Mounting	
	Wide A	High B	Deep C	D	E
2, 3, & 4	95.3	49.3	3.3	68.3	35.1
6 & 7	101.6	55.6	3.3	73.2	41.4

Approximate Dimensions in mm

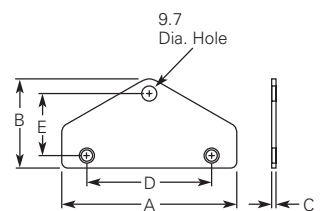

**Chain Hook Bracket**

# Control and indication

## Eaton 30.5 mm pushbuttons

### Dimensions & Technical data

#### Features

- Heavy-duty zinc die cast construction
- Enclosed silver contacts with reliability nibs
- Diaphragm seals with drainage holes
- Grounding nibs on the operator casing

#### Benefits

- Reliability nibs improve contact reliability even under dry circuit & fine dust conditions
- Drainage holes prevent buildup of liquid inside the operator which can prevent operation in freezing environments
- Grounding nibs bite through paint & other coatings to provide secure ground

#### Contact operation

Slow make & break. All normally closed contacts have positive opening operation, i.e., normally closed contacts are forced open in the event of contact weld or spring breakage.

#### Standards & certifications

- CE EN60947-5-1
- UL 508 — File No. 131568
- CSA C22.2 No. 14 — File No. LR68551

Ingress protection (when mounted in similarly rated enclosure):

- Standard Indicating Lights: UL (NEMA) Type 1, 2, 3, 3R, 3S, 4, 4X, 12, 13, IEC IP65
- All Other Operators: UL (NEMA) Type 1, 2, 3, 3R, 4, 4X, 12, 13, IEC IP65

#### Technical data & specifications

Mechanical ratings:

- Frequency of operation: All pushbuttons 6000 operations/hr, Key & lever selector switches 3000 operations/hr, Auto-latch devices 1200 operations/hr.
- Life: Pushbuttons 10 x 106 operations, Contact blocks: 10 x 106 operations, PresTest units 10 x 106 operations, Lever & key selector switches 0.25 x 106 operations, Twist to release pushbuttons 0.3 x 106 operations,
- Shock resistance: Duration 20 mS 5g

Climate conditions:

- Operating Temperature (-17° to 66°C), Storage Temperature (-40° to 80°C), Altitude 2,000m (6,562 ft.), Humidity Max. 95% RH @ 60°C

Terminals:

- Marking: NC-NO on the contact block to meet the NEMA requirements. Dual marking system 1 – 2 for normally closed, 3 – 4 for normally open to meet BS5472 (Cenelec EN50 005)
- Clamps: Terminals are saddle clamp type for 1 x 22 AWG (0.34 mm<sup>2</sup>) to 2 x 14 AWG (2.5 mm<sup>2</sup>) conductors
- Torque = 7 lb-in (0.8 Nm)
- Degree of protection against direct electrical contact: IP2X with fingerproof shroud

Light units:

- Transformers: will withstand short circuit for 1 hour per IEC 60997-5-1
- Bulbs — average life: Transformer type 20,000 hrs., Resistor/direct voltage type 2500 hrs. minimum @ rated V, LED 60,000 to 100,000 hrs.

Electrical ratings:

- Insulation: U<sub>i</sub> = 660V AC or DC
- Thermal: I<sub>th</sub> = 10A
- Short Circuit Coordination to IEC/EN 60947-5-1:
- Rated conditional short circuit current: 1 kA
- Fuse type: GE Power Controls TIA 10, Red Spot Type gG, 10A, 660V AC, 460V DC, BS88-2, IEC 60269-2-1

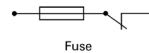

Fuse

- UL rating: A600, P600: AC load life duty cycle 1200 operations/hour (– 10A: 110V pf 0.4 – 1 x 106 operations, – 5A: 250V pf 0.4 – 1 x 106 operations, – 2A: 660V pf 0.4 – 1 x 106 operations)
- Switching capacity: AC15 rated make/break (11 x I<sub>e</sub> at 1.1 x U<sub>e</sub>), (– 6A: 120V pf 0.3, – 4A: 240V pf 0.3, – 2A: 660V pf 0.3). DC13 rated make/break (1.1 x I<sub>e</sub> at 1.1 x U<sub>e</sub>), (– 1.0A: 125V L/R 0.95 at 300 mS, – .55A: 250V L/R 0.95 at 300 mS, – .1A: 660V L/R 0.95 at 300 mS, – 10A: 110V pure resistive)
- Maximum ratings for logic level & hostile atmosphere application: Maximum amperes: 0.5A  
Maximum volts: 120V AC/DC

#### Contact block

Meet or exceed NEMA rating designations **A600, A300 and B300 AC**  
**P600 DC**

Description	Volts SC 50 or 60 Hz				Volts DC		
	120	240	480	60	24	125	250
Make and Emerg. Interruptimng capacity (Amp)	60	30	15	12	5.7	1.1	0.55
Normal load break (Amp)	6	3	1.5	1.2	5.7	1.1	0.55
Thermal current (Amp)	10	10	10	10	5.0	5.0	5.0
<b>Voltampress(VA)</b>							
Make and Emerg. Interruptimng capacity	7200	7200	7200	7200	138	138	138
Normal load break	720	720	720	720	138	138	138

Eaton's electrical business is a global leader with expertise in power distribution and circuit protection; backup power protection; control and automation; lighting and security; structural solutions and wiring devices; solutions for harsh and hazardous environments; and engineering services. Eaton is positioned through its global solutions to answer today's most critical electrical power management challenges.

Eaton is a power management company with 2016 sales of \$19.7 billion. Eaton provides energy efficient solutions that help our customers effectively manage electrical, hydraulic and mechanical power more efficiently, safely and sustainably. Eaton has approximately 95,000 employees and sells products to customers in more than 175 countries.

For more information, visit [www.eaton.com](http://www.eaton.com).



**Eaton**  
Eaton Industries Pty Ltd  
ABN 66 103 014 571  
10 Kent Road  
Mascot NSW 2020  
1300 3 EATON  
[Eatoncorp.com.au](http://Eatoncorp.com.au)

© 2017 Eaton  
All Rights Reserved  
Printed in Australia  
August 2017

Eaton is a registered trademark.

All other trademarks are property  
of their respective owners.

Your Distribution Partner



**1300 36 26 26**  
**[www.colterlec.com.au](http://www.colterlec.com.au)**